

AUTOMATE

Li-ion ARC TUBULAR MOTOR

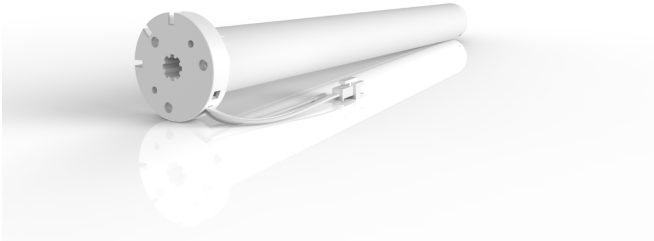

433 MHZ
BI-DIRECTIONAL



ELECTRONIC
LIMIT



SELECTABLE
RPM



FAVORITE
POSITION



LEVEL CONTROL



WIREFREE



SOLAR
POWERED

AUTOMATE | Li-ion ARC motors offer a wirefree rechargeable easy to use and program solution to suit a large range of applications, torques and speeds.

The Leveling Control feature allows for precise positioning of multiple shades ensuring perfect alignment.

Additionally, a favorite position can be pre-set and recalled at any time.

FEATURES:

- Electronic Limits
- 433 MHz Bi-Directional RF Communication
- Leveling Control
- 3 x Selectable Rpm
- Favorite Position
- Roller & Tilt Modes.

CONTENTS

1	ASSEMBLY	5
2	WIRING	6
2.1	Charging options	6
3	P1 BUTTON FUNCTIONS	7
4	INITIAL SET-UP	8
4.1	Pair motor with controller	8
4.2	Check motor direction	8
4.3	Set limits	9
5	ADJUSTING LIMITS	10
5.1	Adjust upper limit	10
5.2	Adjust lower limit	10
6	ADDING OR REMOVING CONTROLLERS AND CHANNELS	11
6.1	Using motor P1 button	11
6.2	Using a pre-existing controller	11
7	FAVORITE POSITIONING	12
7.1	Set a favorite position	12
7.2	Send shade to favorite position	12
7.3	Delete favorite position	12
8	ADJUSTING MOTOR SPEED	13
8.1	Increase or decrease motor speed	13
9	TILT & ROLLER MODE	14
9.1	Enter tilt mode	14
9.2	Enter roller mode (Default)	14
10	TROUBLESHOOTING	15

SAFETY INSTRUCTIONS

WARNING: Important safety instructions to be read before installation.

Incorrect installation can lead to serious injury and will void manufacturer's liability and warranty.

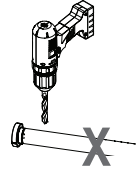
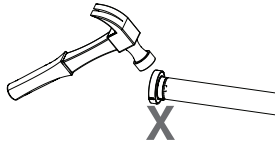

CAUTION

- Do not expose to moisture or extreme temperatures.
- Do not allow children to play with this device.
- Use or modification outside the scope of this instruction manual will void warranty.
- Installation and programming to be performed by a suitably qualified installer.
- For use within tubular blinds.
- Ensure correct crown and drive adaptors are used for the intended system.
- Keep antenna straight and clear from metal objects
- Do not cut the antenna.
- Use only Rollease Acmeda hardware.
- Before installation, remove any unnecessary cords and disable any equipment not needed for powered operation.
- Ensure torque and operating time is compatible with end application.
- Do not expose the motor to water or install in humid or damp environments.
- Motor is to be installed in horizontal application only.
- Do not drill into motor body.
- The routing of cable through walls shall be protected by isolating bushes or grommets.
- Ensure power cable and aerial is clear and protected from moving parts.
- If cable or power connector is damaged do not use.

Important safety instructions to be read prior to operation.

- It is important for the safety of persons to follow the enclosed instructions. Save these instructions for future reference.
- Persons (including children) with reduced physical, sensory or mental capabilities, or lack of experience and knowledge should not be allowed to use this product.
- Keep remote controls away from children.
- Frequently inspect for improper operation. Do not use if repair or adjustment is necessary.
- Keep motor away from acid and alkali.
- Do not force the motor drive.
- Keep clear when in operation.



Do not dispose of in general waste.
Please recycle batteries and damaged electrical products appropriately.



1 ASSEMBLY

Please refer to Rollease Acmeda System Assembly Manual for full assembly instructions relevant to the hardware system being used.

Step 1. Cut roller tube to required length.

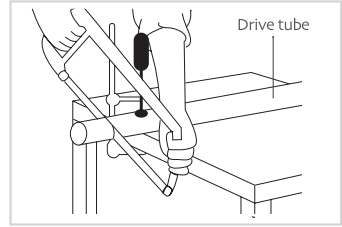

Step 2. Ensure roller tube is clean and free from burrs.

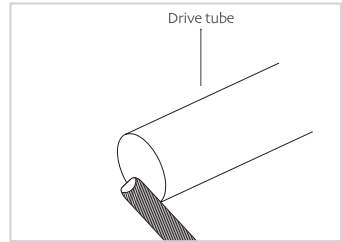

Step 3. Fit required crown, drive and bracket adapters.

Tube must be close fitting with chosen crown and drive adapters. Refer to Rollease Acmeda System Assembly Manual for recommended crown, drive, and bracket adapter kits.

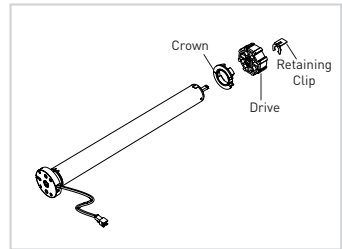

Step 4. Slide Motor into tube.

Insert by aligning keyway in crown and drive wheel to the tube.

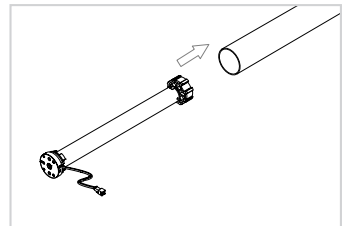

Step 5. Mount motorized tube onto brackets.

Refer to Rollease Acmeda System Assembly Manual for recommended crown, drive, and bracket adapter kits.

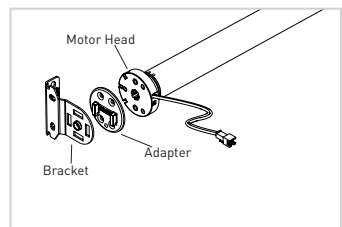

2.1 Charging options

This motor has a 12V built in Li-ion battery pack with integrated charge management.

Max power input for recharging: 12.6V / 1000mAh.

- Before first use please charge motor for 6 hours. Using the recommended AC charger.
- During operation, if voltage drops to less than 10V, the motor will beep 10 times to prompt it needs to be charged.
- Motor will stop running when the voltage is lower than 7V and it will resume again when the voltage is greater than 7.5V.

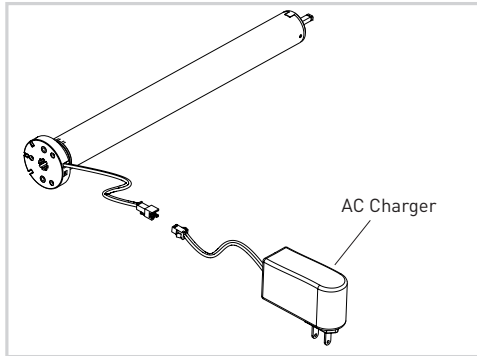

ITEM NO.:
MTDCB-CHARGE-US
MTDCB-CHARGE-AU
MTDCB-CHARGE-EU

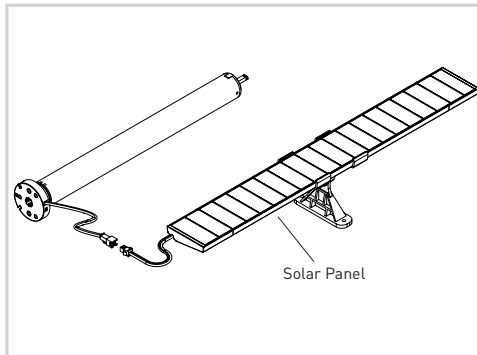

ITEM NO.:
MTSOLPAN-B



Ensure cable is kept clear of fabric.

Ensure antenna is kept straight and away from metal objects.

3 P1 BUTTON FUNCTIONS

P1 Press	Condition	Function Achieved	Visual Feedback	Audible Feedback	Function Described
Short Press	If limit is NOT set	None	No Action	None	No Action
	If limits are set	Operational control of motor, run to limit. Stop if running	Motor runs	None	Operational control of motor after pairing and limit setting is completed first time
	If motor is in "Sleep Mode" & limits are set	Wake and control	Motor wakes and runs in a direction	None	Motor is restored from Sleep Mode and RF control is active

Hold P1

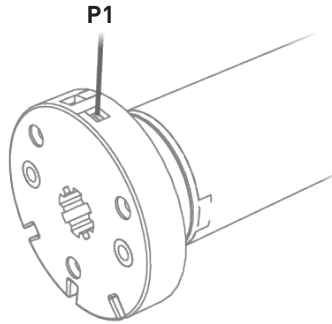

Activate Pairing Mode

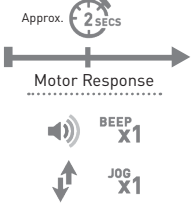

Sleep Mode

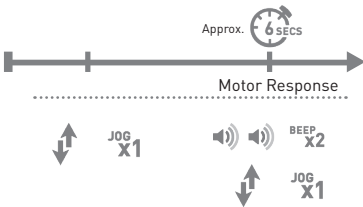

Reverse Direction

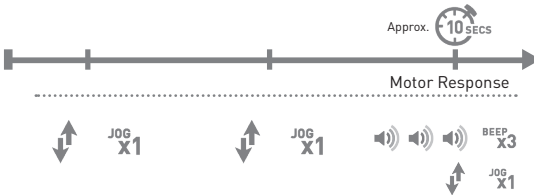

Reset To Factory Settings

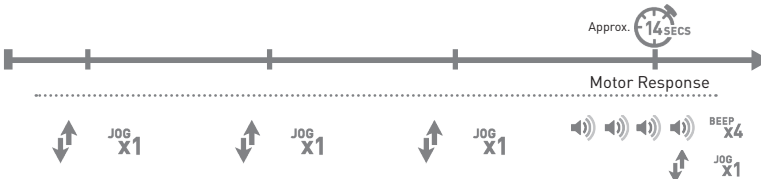

4 INITIAL SET-UP

4.1 Pair motor with controller

Select channel on controller.



Hold **P1** button on motor head.

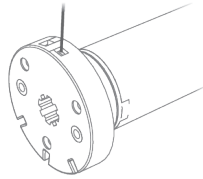

Hold **STOP** on controller.



IMPORTANT

Consult user manual for your controller for information on selecting channel.

Motor Response



Motor Response



Motor is now in step mode and ready for setting limits

4.2 Check motor direction

To check travel direction of shade, press **UP** or **DOWN** on controller.

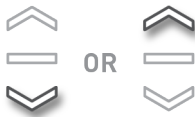

To reverse shade direction, hold both **UP** and **DOWN**.



Quick Press = Step

Long Press = Continuous Travel

Motor Response



IMPORTANT

Damage to shade may occur when operating motor prior to setting limits. Attention should be given.



IMPORTANT

Reversing motor direction using this method is only possible during initial set-up.

4.3 Set limits

To save upper limit, hold **UP** and **STOP**.

Move shade to the desired highest or lowest position by pressing the **UP** or **DOWN** buttons on controller.



To save lower limit, hold **DOWN** and **STOP**.



IMPORTANT

Cycle shade up and down prior to setting limits to settle fabric

Motor Response



IMPORTANT

After setting limits, motor will automatically exit from initial set-up mode.



Initial set-up is now complete

5 ADJUSTING LIMITS

5.1 Adjust upper limit

Hold **UP** and **STOP** on controller.



Move shade to the desired highest position by pressing the **UP** button.



To save upper limit, hold **UP** and **STOP**.



Motor Response



Motor Response



5.2 Adjust lower limit

Hold **DOWN** and **STOP** on controller.



Move shade to the desired lowest position by pressing the **DOWN** button.



To save lower limit, hold **DOWN** and **STOP**.



Motor Response



Motor Response



6 ADDING OR REMOVING CONTROLLERS AND CHANNELS

6.1 Using motor P1 button

Hold **P1** button on motor head.

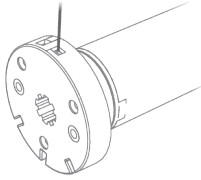

Hold **STOP** on controller to add or remove.



Motor Response

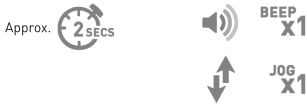

Motor Response



6.2 Using a pre-existing controller

A= Existing controller or channel (to keep)

B= Controller or channel to add or remove

Press **P2** on existing controller.



Press **P2** on existing controller.

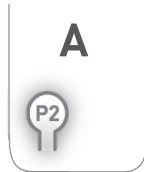

Press **P2** on new controller.

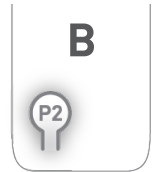

Motor Response



Motor Response



Motor Response



IMPORTANT

Consult user manual for your controller or sensor.

7 FAVORITE POSITIONING

7.1 Set a favorite position

Move shade to the desired position by pressing the **UP** or **DOWN** button on the controller.



Press **P2** on controller.



Press **STOP** on controller.



Press **STOP** on controller.



Motor Response



Motor Response



Motor Response



7.2 Send shade to favorite position

Hold **STOP** on controller.



7.3 Delete favorite position

Press **P2** on controller.



Press **STOP** on controller.



Press **STOP** on controller.



Motor Response



Motor Response



Motor Response



8 ADJUSTING MOTOR SPEED

8.1 Increase or decrease motor speed

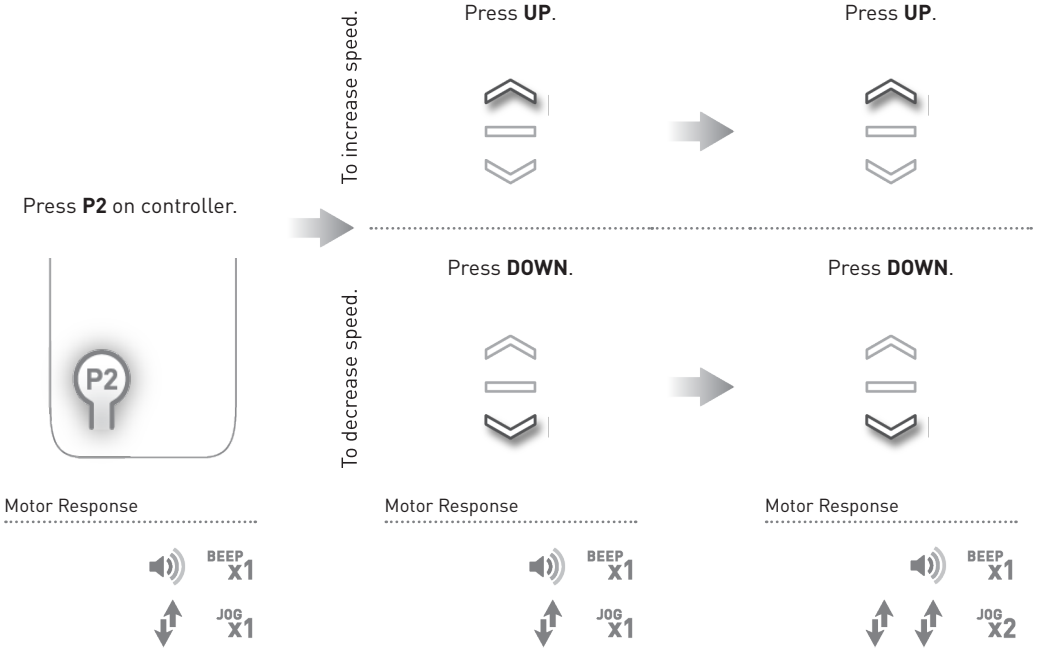

! IMPORTANT

If motor does not react to speed adjustment, the maximum or minimum speed has already been reached.

9 TILT & ROLLER MODE

9.1 Enter tilt mode

Hold **UP** and **DOWN** on controller.



Press **STOP**.



Motor Response



JOG X1

Motor Response



BEEP X1



JOG X1

9.2 Enter roller mode (Default)

Hold **UP** and **DOWN** on controller.



Press **STOP**.



Motor Response



JOG X1

Motor Response



BEEP X3



JOG X2

10 TROUBLESHOOTING

Problem	Cause	Remedy
Motor is not responding	Battery in motor is depleted	Recharge with compatible AC adaptor and check connection and positioning of PV panel.
	Insufficient charging from Solar (PV) Panel	Check connection and orientation of PV panel.
	Transmitter battery is discharged	Replace battery
	Battery is inserted incorrectly into transmitter	Check battery polarity
	Radio interference/shielding	Ensure transmitter is positioned away from metal objects and the aerial on motor or receiver is kept straight and away from metal
	Receiver distance is too far from transmitter	Move transmitter to a closer position
	Power failure	Check power supply to motor is connected and active
	Incorrect wiring	Check that wiring is connected correctly (refer to motor installation instructions)
Motor beeps 10 times when in use	Battery voltage is low / PV (solar) panel issue	Recharge with AC adaptor or check connection and positioning of PV pane
Cannot program a single Motor (multiple motors respond)	Multiple motors are paired to the same channel.	Always reserve an individual channel for programming functions
		SYSTEM BEST PRACTICE - Provide an extra 15 channel remote in your multi motor projects, that provides individual control for each motor for programming purposes
		Place all other motors into sleep mode (ref to P1 function overview - section 3)

ROLLEASE ACMEDA
AUSTRALIA

110 Northcorp Boulevard,
Broadmeadows VIC 3047
T +61 3 9355 0100 | F +61 3 9355 0110

Western Australia Branch
Unit 1, 41 Mulgool Road,
Malaga WA 6090
T +61 8 9248 5571 | F +61 8 9248 5572

Queensland Branch
Unit 2/62 Borthwick Avenue,
Murarrie QLD 4172

ROLLEASE ACMEDA
USA

200 Harvard Avenue
Stamford, CT 06902 6320
T +1 203 964 1573 | F +1 203 964 0513

ROLLEASE ACMEDA
EUROPE

Via Conca Del Naviglio 18, Milan
(Lombardia) Italy
T +39 02 8982 7317 | F +39 02 8982 7317

info@rolleaseacmeda.com
rolleaseacmeda.com
